

# Petroleum Storage

Containment Solutions™ Underground Fiberglass Tanks



Fiber Glass Systems | **NOV**



83 100  
E WALL  
100 GALLONS

# Why our tanks are your best investment

In the early 1960s, the American Petroleum Institute challenged Fiber Glass Systems LP to develop a rustproof underground storage tank that would be safe and strong enough to satisfy the petroleum industry's most stringent long-term storage demands.

Our engineers accepted the challenge and pioneered the underground fiberglass tank technology. Our innovative design work resulted in the UL 1316 specification which governs underground fiberglass tank manufacturing.

Over 50 years later, we continue to improve upon those processes utilizing today's automation to develop new applications and products.

Fiber Glass Systems LP is proud to be **the largest American fiberglass tank manufacturer.**

# We will continue to lead, far into the future, thanks to the vision of everyone on our team

Our success is a direct result of our commitment to offering the highest quality products backed by the highest level of service. You can expect more than just a product you can also count on:

- **Dedication to research and development.** We focus our talents on pushing the limits of what is possible in order to provide you with quality products that meet your needs at a competitive price.
- **Technologically superior manufacturing process.** We utilize the finest materials and methods to produce high-quality products that have led the industry for over four decades.
- **Environmentally focused.** We are committed to providing environmentally conscious designs and products. As a member of the U.S. Green Building Council, we promote proper fluid management and sustainable site development.
- **Industry-leading support.** We have the most knowledgeable sales force and the only National field service organization staffed by full-time company employees. Our technical support group promptly and clearly answers technical questions about our products or services. They, along with our exceptional inside sales department, are committed to supplying “value-added” service that complements our exceptional products.

Fiber Glass Systems invites you to review our state-of-the-art underground fiberglass tank products at four conveniently located manufacturing facilities in Bakersfield, CA; Mt. Union, PA; Tulsa, OK; and Grand Bay, AL.



Our tanks carry the Underwriters Laboratories listing.



**Superior automated process**



**Tanks compatible with bio fuels and ethanol**

## Manufacturing Processes

### Automated manufacturing process

We use steel mandrels (cylindrical molds) to build our tanks from the inside out. The molds provide a firm and consistent surface upon which we apply materials to make our tank. The rotating mandrel and the application of the materials are controlled by a computer, custom designed to manufacture underground tanks. As the mandrel rotates; resin, glass and specially treated silica are precisely metered onto the mandrel from above.

Tank thickness is determined with an instrument that magnetically senses the metal mold surface through the fiberglass reinforced plastic laminate. This method accurately measures the thickness of the laminate using specific points all over the surface of the tank wall and is more exact than the ultrasonic methods used by other manufacturers. The result is a closely controlled process and a very consistent tank wall composition providing uniform integrity.

### Different process, better results

The inside-out approach to manufacturing tanks is a superior process with unique advantages. Inner Surface: The initial material forming against the steel mold produces an incredibly polished finish, free of surface variations. The smooth inside surface in our process is not exposed to air as it cures thus eliminating air inhibited cure issues. The result is a well cured,

high gloss inner surface without the need for interior liners. Other manufacturing methods rely on inferior hand sprayed wax coatings to combat surface cure problems. Outer Surface: Exterior reinforcement ribs are applied in optimal locations and constructed of the most efficient reinforcing materials. We can also modify a tank by adding filament winding glass in tension, glass woven roving, glass mat, or any other materials in specific locations on the outside of the tank wall. Our entire shell wall surface is manufactured with the same corrosion resistant resin. With our homogeneous tank shell, you can be assured the exterior surface has the same compatibility properties as the interior surface. We do not use liners or special coatings on any tank surface.

Another significant advantage of our inside-out manufacturing process that uses a rigid mold as the foundation and framework for delivering a uniform inner diameter and therefore insures tank capacity is always consistent. If additional tank wall is necessary, we simply add thickness to the outside surface. In contrast, an outside-in process by definition relies upon a fixed outer diameter and variable inner diameter. To add thickness using this process glass, resin and hand sprayed liners are applied to the inner surface sacrificing maximum tank capacity. Simply put, our process allows for a more versatile and dependable product.

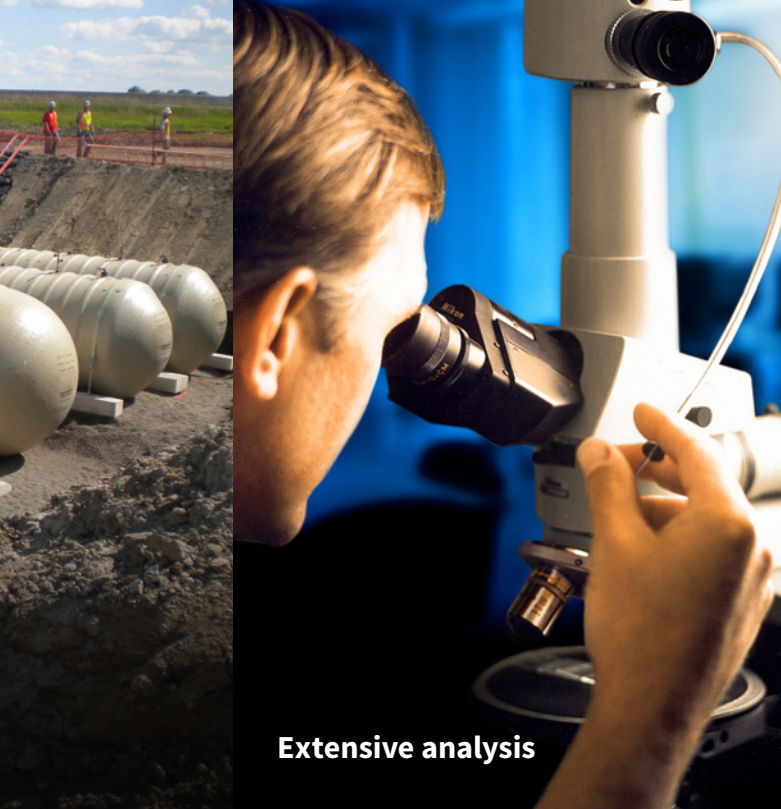

Extensive analysis

Our commitment to excellence begins in the Research and Development Center. No other tank manufacturer has invested the amount of time and resources, to not only product development but product enhancement. Our engineers use the latest technology to analyze tank compatibility for alternative fuels and unique fluids like Urea DEF. For our experts, tank testing is a science measured in decades.

**We focus our talents on pushing the limits of what is possible.**

## Research and Development

### Engineered and tested corrosion resistance

The tank wall is composed of resin, glass and a specially treated silica that together result in a composite matrix compatible with petroleum industry products including:

- All Octanes of Gasoline
- AV-Gas
- Ultra Low Sulfur Diesel (ULSD)
- Fuel oil
- Oxygenated Motor Fuels
- Jet Fuel
- Motor Oil
- Renewable Diesel and Bio-Diesel
- Ethanol, all blends up to 100%
- Kerosene

Fiber Glass Systems instituted and perfected the use of a specially treated silica in our laminate matrix. The unique silica is an engineered component enhancing the performance of our laminate. Our exclusive laminate has been thoroughly tested to meet the requirements of UL/ULC 1316.

Long-term corrosion and material properties testing is done at our Research and Development Center (R&D). Laminate testing includes current fuels, blends and other oxygenates, but we do not stop there. We also test alternative products and blends

that could be stored in our tanks in the future; as fuel options change, your storage tank compatibility will not.

Many of the newest industry fuels and biofuels are alcohol based. Alcohol blends, including ethanol, increase the likelihood of water in a storage tank, resulting in rust and microbial-induced corrosion (MIC) in steel tanks. The inherent non-corrosive nature of a fiberglass tank eliminates the possibility of rust on all tank wall surfaces. Extensive corrosion testing allows us to confidently offer an industry leading 30-year warranty while most steel tank manufacturers have reduced their warranties to 10 years.

Our R&D has authored patents and expert reports introducing cutting-edge products like double-wall sumps and the first independently verified Urea DEF underground tank. Since the first non-corrosive tank was designed back in the 1960s, we have maintained the highest quality standards and have utilized advanced technologies to engineer and build the world's premier fiberglass storage tank.

# Double-Wall Tanks

Our advanced double-wall technology gives storage tank owners, municipalities, counties, provinces, and states proven protection against petroleum contamination of underground water supplies. In addition to our UL listing, our tanks comply with the EPA's recommendation for secondary containment systems wherever underground tanks are located near underground water supplies.

Containment Solutions™ double-wall tanks give you two levels of protection, so you have twice the assurance and twice the risk management that any single-wall tank can offer. The primary tank is designed to contain your fuel. In the unlikely event that there is a breach in this wall, the secondary wall is designed to contain your product and prevent seepage into the environment.

## Hydrostatic monitoring

For the most effective double-wall storage tank protection, we recommend hydrostatic monitoring. The cavity between the inner and outer tank walls (interstitial space), as well as a factory mounted reservoir, is filled with a non-toxic colored brine solution. Hydrostatic pressure is continuously applied to the interstitial space, enabling monitoring of the primary and secondary tanks. An electronic sensor in the tank reservoir will send an alarm if the brine level changes beyond a predetermined level.

Our Hydrostatic Monitoring System offers a leak detection capability superior to other methods because of our unique tank construction. The independent tank wall design ensures that 100% of the primary and secondary tank walls are in contact with monitoring fluid. This open environment allows brine to move freely through the interstitial space, unimpeded by glass fabric bonded to the tank walls typically used in competitive designs. Since the unblocked interstitial space does not hinder communication, the Hydrostatic Monitoring System is fast and effective.

## Hydrostatic monitoring

detects leaks in either the primary or secondary tank walls in all installed conditions.

### NORMAL CONDITIONS

The reservoir liquid level will be stable if both the inner and outer tank are tight. The reservoir sensor will activate an alarm if the reservoir drains or overfills.

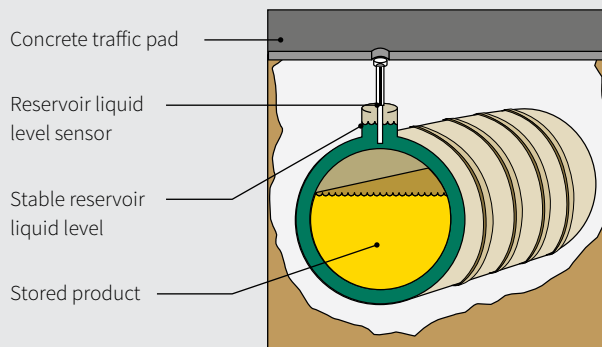

### INNER WALL BREACH

Monitor fluid drains into the primary tank causing the reservoir to drain. The petroleum product remains safely contained in the primary tank.

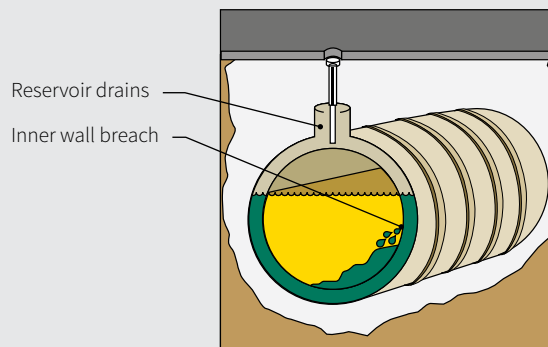

## Superior protection with Hydroguard®

The HydroGuard System is the most dependable storage system available. HydroGuard combines the UL listed double-wall tank and double-wall tank sumps for a fully integrated hydrostatically monitored storage system. HydroGuard also comes with a deadman anchoring system, completing the underground storage solution.

As the name suggests, the HydroGuard System utilizes hydrostatic pressure to provide a proven means of monitoring for leaks 24 hours a day, 7 days a week. In fact, our hydrostatic monitoring system has been certified as a continuous leak detection system by the National Work Group on Leak Detection Evaluations, (NWGLDE).

Unlike typical storage systems, HydroGuard provides 360° secondary containment of not only the stored product in the tank but the critical piping components above the tank. Containment Solutions double-wall tank sumps are state-of-the-art including built-in brine reservoirs and street accessible reservoir sensor housing. The turbine and fill/vapor sumps are continuously monitored for the ultimate in underground fuel storage protection.

The HydroGuard System is available in a Multi-Sump or Single-Sump option to meet your specific requirements. The multi-sump system, which includes both the turbine and fill/vapor sumps, was designed to meet the most stringent regulations, like California's AB 2481.

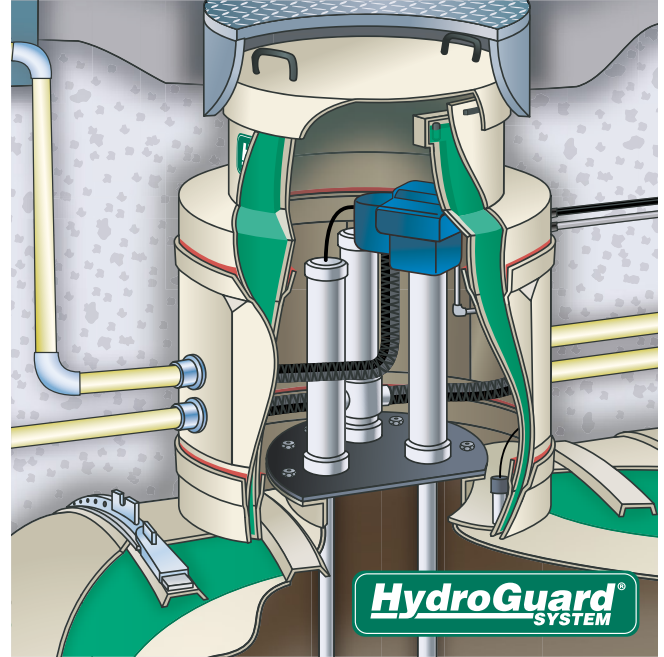

The HydroGuard System is a complete hydrostatically monitored double-wall storage system.

### OUTER WALL BREACH

If the groundwater is below the tank top, the non-toxic monitor fluid drains into the ground causing the reservoir to drain.

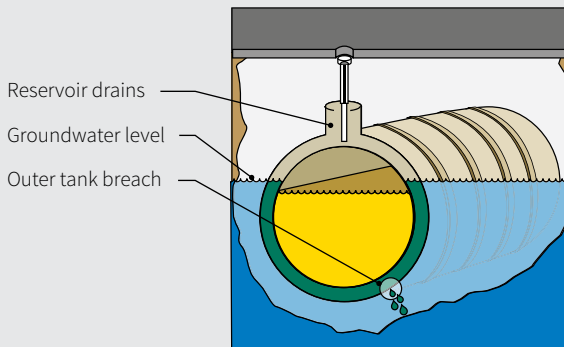

### HIGH GROUNDWATER

If the groundwater is over the tank top, the reservoir will overflow with groundwater and activate the high level alarm on the reservoir sensor.

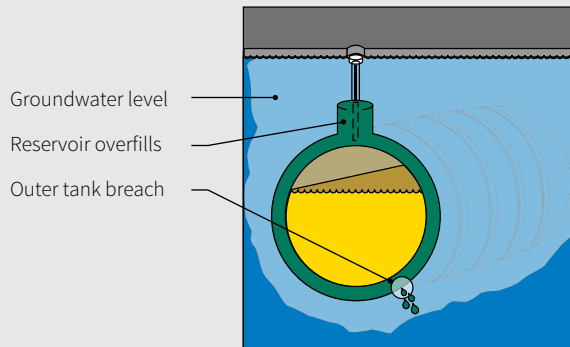

# Retail Gasoline System Overview

## Innovative Manufacturing Process

Using an automated process, our tank laminate is consistent in thickness and composition and is fabricated with an inner surface that is not air-inhibited. The resulting tank can safely store petroleum fuel products, alcohols and alcohol gasoline mixtures of virtually any blend.

Our proven performance and high quality products have led the industry for over 50 years.

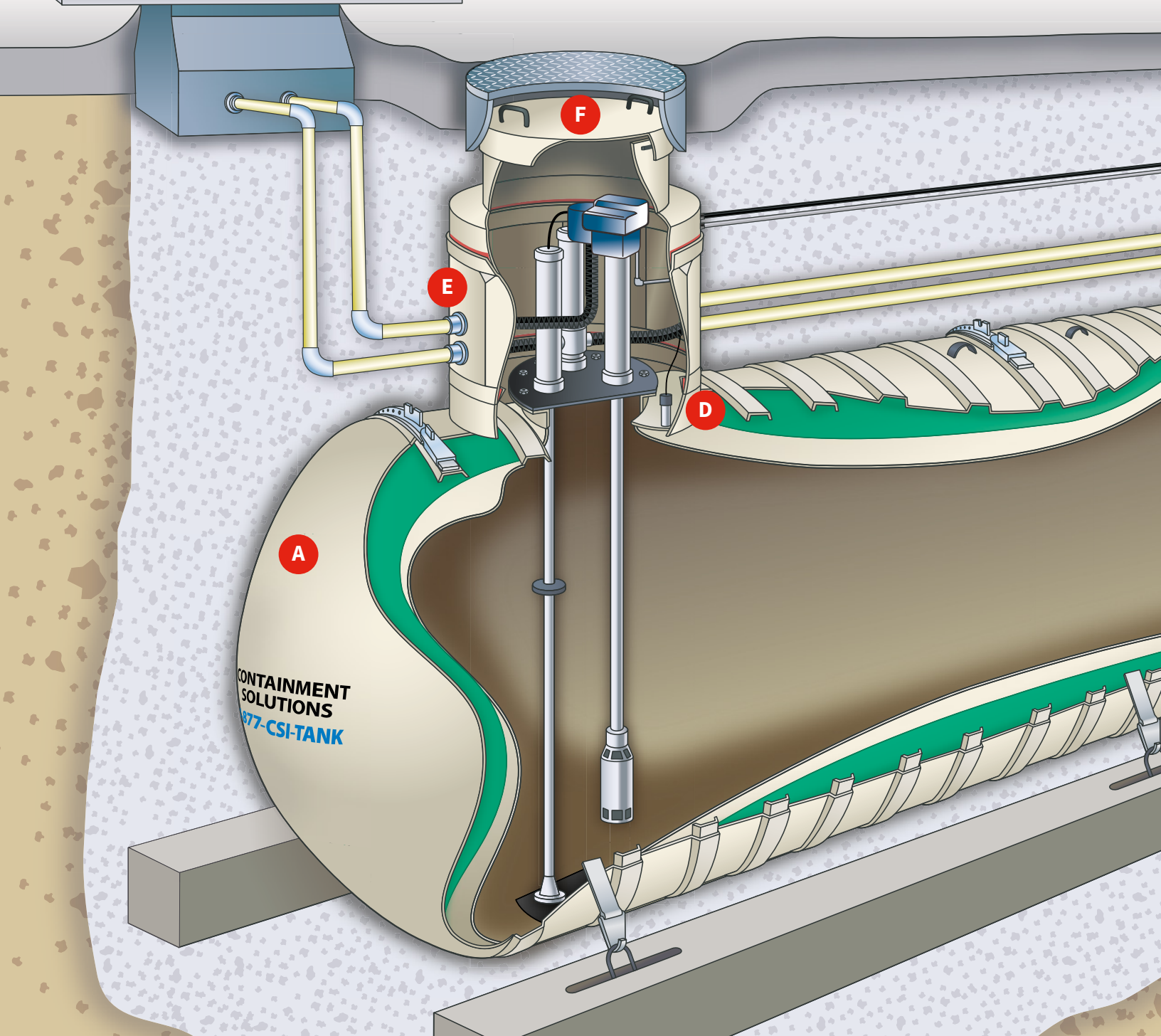



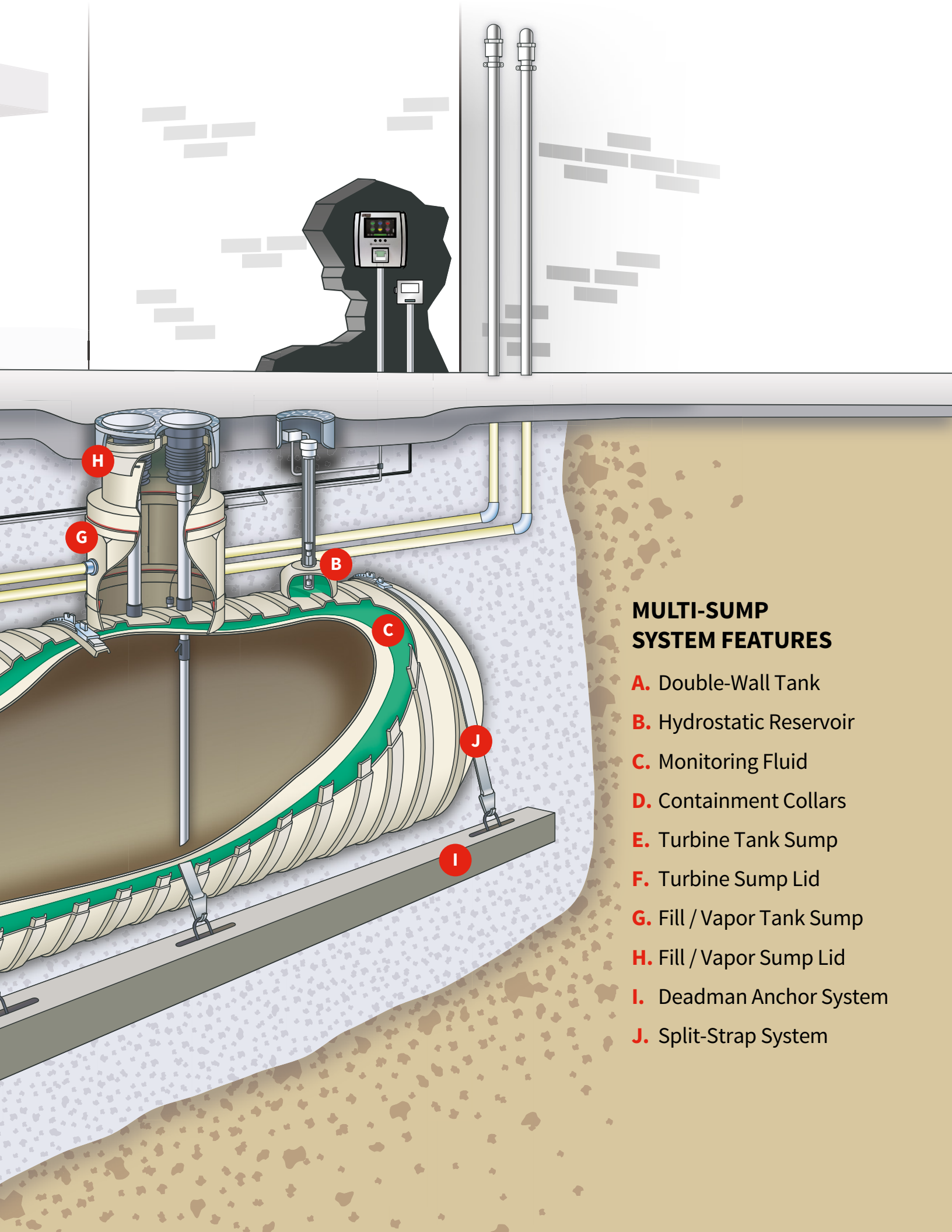

## MULTI-SUMP SYSTEM FEATURES

- A.** Double-Wall Tank
- B.** Hydrostatic Reservoir
- C.** Monitoring Fluid
- D.** Containment Collars
- E.** Turbine Tank Sump
- F.** Turbine Sump Lid
- G.** Fill / Vapor Tank Sump
- H.** Fill / Vapor Sump Lid
- I.** Deadman Anchor System
- J.** Split-Strap System

# Additional Storage Options

Every installation is unique, sometimes involving single-wall tanks, triple-wall tanks, or compartment tanks. Fiber Glass Systems has a complete range of products and accessories to meet our customer's needs.

## Single-wall tanks

The very first fiberglass underground petroleum storage tank was a single-wall design and for 45 years single-wall tanks were installed around the world. As petroleum regulations changed single-wall tanks were phased out and although we no longer produces single-wall tanks for fuel storage, the original design is still utilized in other applications like water storage and separators / interceptors. Single-wall tanks use the same manufacturing methods and laminate matrix as our double-wall designs.

## Triple-wall tanks

In 1997, we designed the first UL listed triple-wall fiberglass tank for use in environmentally sensitive areas where tertiary containment is required. Triple-wall tanks offer three levels of protection: the proven strength and performance of a primary fiberglass tank, and in the unlikely event that there is a breach, secondary and tertiary walls designed to contain the fuel and prevent any spill into the environment.



## Compartment Tanks

Compartment tanks are built by dividing a storage tank with a single-wall or double-wall bulkhead, creating two or more independent storage areas. They are a popular choice for retail petroleum marketers interested in storing multiple blends of fuel, including diesel. Since compartment tanks can be divided to accommodate two or more grades of fuel, they allow the site designer to plan for any ratio of fuel storage. These tanks are often used for sites where property is limited and installing multiple tanks is difficult. The design versatility of a Containment Solutions compartment tank can meet unique customer requests as well as local requirements.

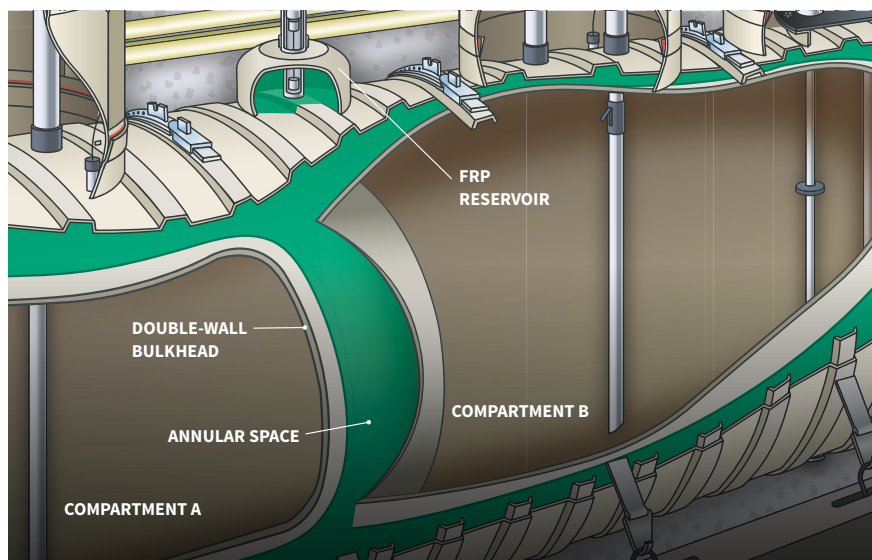

## Benefits of compartment tanks

- Reduced shipping costs with fewer tanks
- Fewer labor hours during installation with fewer tanks
- Smaller excavation sites needed for fewer tanks
- Size is more adaptable to changing consumer demands



## Fiberglass Tank Sumps

Containment Solutions tank sumps are manufactured and shipped as individual components such as sump bodies, enclosure tops, lids and adhesive kits. Each sump is then assembled in the field using our unique adhesive channels.

With 42, 48, and 54 in. sump diameters available and multiple lid configurations; we offer the widest range of options for protecting your **tank top hardware and piping**.

## Accessories

### Fiberglass Tank Sumps

Protecting your storage system and the surrounding environment includes protecting the components that connect to the tank. Pumps and piping often require annual or semi-annual maintenance and testing. Without a sump, buried components are difficult to access and service.

Tank sumps are protective enclosures for pumps, piping and other accessories above the tank top. Fiber Glass Systems provides a full line of UL 2447 listed fiberglass tank sumps in round and polygon designs, available in 42 in. or 48 in. diameter. 54 in. diameter sumps are available for applications such as backup generators at hospitals or data centers. Containment Solutions tank sumps can be ordered in single or double-wall construction.

For over 20 years we have been perfecting the tank sump design and installation process, creating the most reliable and contractor friendly sump line available. Our proven technology has been utilized in thousands of installations.

### Containment Collars

The protection of system components above the tank top begins with the containment collar. Our collars are factory bonded to the tank wall, and engineered to fit the single or double-wall tank sump specified. The collars feature a built-in adhesive channel making field bonding installation easier than ever.

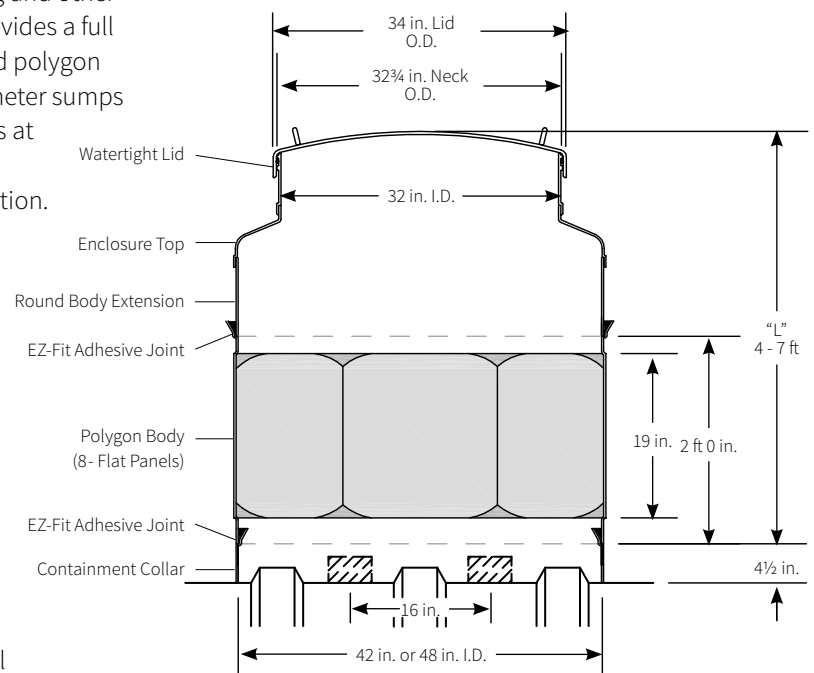

Single-Wall Tank Sump with Watertight Lid



**Single-Wall  
tank sump EZ-Fit joint**

## Watertight Dependability

An alternative to the traditional lay-up, the unique EZ-Fit adhesive channel facilitates a permanent and watertight joint which protects against leaks. The no mess installation is an easier and more effective way to ensure a watertight connection.



**Double-Wall  
tank sump EZ-Fit joint**

## Tank sump lids

Turbine tank sump lids are used at the submersible turbine end of the tank when access is infrequent and the area must be watertight. The turbine lid is made of rigid fiberglass and fits into place by simply pushing down on the lid. Comfort grip handles make removal of the lid convenient.

Fill/Vapor tank sump lids are available for the fill-end of the tank when multi-port manholes are used. We offer two access opening options to accommodate the most popular shroud boots and spill containment systems. Both configurations include an observation port allowing easy access for internal sump inspections. Quad fill lids are also available on 48 in. and 54 in. tank sumps.



Turbine lid



Fill/Vapor Lid  
w/ 15 in. access openings



Fill/Vapor lid  
w/ 13 in. access openings

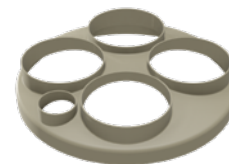

Quad fill lid

## Watertight tested

Lid assemblies are tested to 1 ft of hydrostatic head pressure to ensure a watertight seal. Access and removal of lids is possible through a standard street boxes.

## 100% Secondary containment

Several competitive products bond the sump walls together using glass fabrics, this can result in triggering false alarms due to poor communication in the monitoring system. Containment Solutions Double-wall tank sumps are built with two completely independent walls. This open environment offers the perfect communication pathway for hydrostatic monitoring which means reliable 360° protection.



## Features and Benefits

- Designed to ACI code
- Adjustable anchor points
- Works with all tank diameters and lengths
- Ships alongside most tanks, reducing freight cost
- Fiberglass split straps available for man-out-of-hole installation

## Deadmen Tank Anchors

Fiber Glass Systems can provide factory deadmen tank anchors, engineered to American Concrete Institute (ACI) standards, for fiberglass storage tanks. Deadmen anchoring systems prevent storage tanks from floating when excessive ground water is present. Ordering a complete deadmen system, with turnbuckles and straps, is a ready-made solution for your tank anchoring needs. Typically the entire package is delivered on the same truck as the tank, saving you construction time and shipping costs. Each anchoring system is sized for your specific tank configuration and arrives ready to install.

### Low-Profile 18 in. x 8 in. Deadman

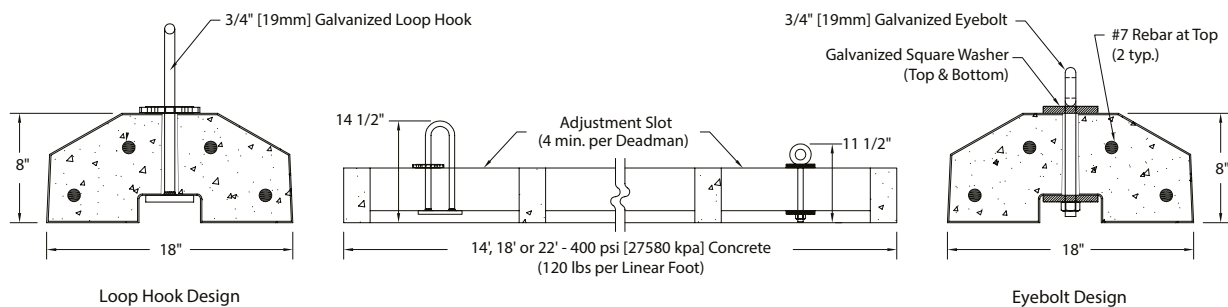

### 12 in. x 12 in. Deadman

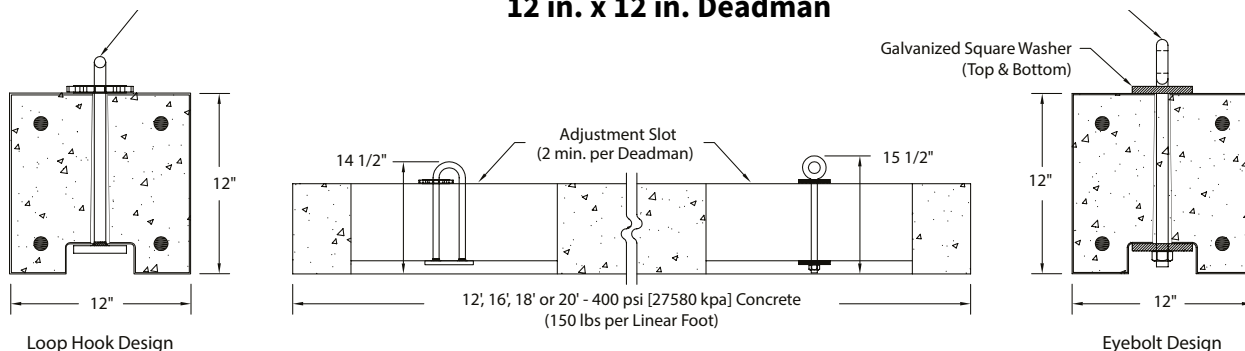

# Field Services

We proudly stand behind our products which is why we have an entire division fully staffed by experienced technicians for field services. We are the only major manufacturer of fiberglass storage products with a full time staff and we service not only our products but our competitors' products as well.

## ReTank®

ReTank® is an on-site retrofit system which allows you to turn any fiberglass single-wall tank into a hydrostatically monitored double-wall tank. The benefits include reducing the costs of tank replacement and using existing tanks for multiple types of fuel.

With the ReTank system, a fiberglass inner tank is constructed in sections and then installed in your existing tank, still in the ground. While in your tank, our technicians perform a full inspection, upgrade all fittings to current standards, and install all the safeguards of our newest double-wall tanks.

## BTU® - biofuel tank upgrade

The BTU®, Biofuel Tank Upgrade, is a cost-effective solution for upgrading existing fiberglass single-wall tanks to meet new regulations. Many of the earliest generation fiberglass tanks were not tested nor were they warranted for either biodiesel or ethanol blends exceeding 10%.

What makes BTU different from other upgrades? BTU is a tank enhancement, it is not a spray-on liner. Tank liners have an unfortunate history of failure which is why you should only trust a tank manufacturer with future upgrades. The BTU service is completed by our field technicians who are experts in fiberglass tank manufacturing techniques. BTU can be applied in combination with other tank modifications like sumps and collars or as a stand-alone service.

## Compartment Tank Upgrades

Our Field Service can add a bulkhead to an existing underground storage tank creating a multi-compartment tank. Modifying existing tanks can expand the available product offering for a fraction of the cost of tank replacement. The compartment tank upgrade will not affect the tank warranty and minimizes dispenser down time. The multi-compartment tank will be operational in a few days and is fully compatible with the same fuels as all other Containment Solutions tanks.



# Standard Tank Sizes

The following table represents the most popular tank sizes at various tank diameters. Dimensions are based on double-wall brine filled tank designs and gallon capacities.

Diameter	Model	Capacity (gallons/liters)	Length (ft/m)	Weight (lbs/kilos)	Number of Straps
4 ft.	600	606 / 2,294	7 ft. 3 in. / 2.20	975 / 442	2
	1000	966 / 3,657	117 ft. 1 in. / 3.37	1,235 / 560	2
	1400	1,412 / 5,344	157 ft. 10 in. / 4.82	1,400 / 635	2
	2000	2,000 / 7,571	227 ft. 2 in. / 6.75	2,000 / 907	4
6 ft.	2000	2,107 / 7,976	117 ft. 0 in. / 3.35	2,200 / 998	2
	2500	2,689 / 10,179	137 ft. 9 in. / 4.19	2,650 / 1,202	2
	3000	3,323 / 12,579	167 ft. 9 in. / 5.10	3,000 / 1,360	2
	4000	3,958 / 14,983	197 ft. 9 in. / 6.01	3,550 / 1,610	2
	5000	5,015 / 18,984	257 ft. 0 in. / 7.62	4,350 / 1,973	4
	6000	6,179 / 23,390	307 ft. 3 in. / 9.22	5,100 / 2,313	4
8 ft.	4000	3,998 / 15,134	147 ft. 0 in. / 4.26	3,150 / 1,428	2
	6000	5,897 / 22,323	197 ft. 6 in. / 5.94	4,050 / 1,837	2
	8000	7,796 / 29,511	257 ft. 0 in. / 7.62	5,000 / 2,268	2
	10000	9,696 / 36,703	307 ft. 6 in. / 9.29	5,950 / 2,698	4
	12000	11,595 / 43,892	367 ft. 0 in. / 10.97	7,050 / 3,197	4
	15000	14,545 / 55,059	447 ft. 7 in. / 13.58	9,350 / 4,241	4
	20000	20,343 / 77,006	617 ft. 4 in. / 18.69	13,900 / 6,305	6
10 ft.	10000	10,257 / 38,827	207 ft. 11 in. / 6.37	7,500 / 3,402	3
	15000	15,104 / 57,175	297 ft. 3 in. / 8.91	10,500 / 4,762	4
	20000	19,951 / 75,523	377 ft. 6 in. / 11.43	13,550 / 6,146	4
	25000	24,970 / 94,522	467 ft. 0 in. / 14.02	17,100 / 7,756	6
	27000	26,585 / 100,634	487 ft. 9 in. / 14.85	18,150 / 8,232	8
	30000	29,816 / 112,866	607 ft. 1 in. / 18.31	20,400 / 9,253	8
	35000	34,835 / 131,865	637 ft. 1 in. / 19.22	24,350 / 11,045	8
	40000	39,854 / 150,864	717 ft. 4 in. / 21.74	27,750 / 12,587	10
12 ft.	20000	20,045 / 75,879	277 ft. 7 in. / 8.40	21,500 / 9,752	6
	25000	25,485 / 96,471	347 ft. 7 in. / 10.54	26,100 / 11,838	8
	30000	30,147 / 114,119	407 ft. 8 in. / 12.39	30,350 / 13,766	10
	35000	35,456 / 134,216	477 ft. 5 in. / 14.45	35,100 / 15,921	10
	40000	40,118 / 151,863	537 ft. 5 in. / 16.28	39,050 / 17,713	12
	45000	45,557 / 172,452	607 ft. 5 in. / 18.41	43,650 / 19,799	12
	50000	50,090 / 189,611	667 ft. 3 in. / 20.19	47,650 / 21,614	14

NOV Inc. has produced this brochure for general information only, and it is not intended for design purposes. Although every effort has been made to maintain the accuracy and reliability of its contents, NOV Inc. in no way assumes responsibility for liability for any loss, damage or injury resulting from the use of information and data herein. All applications for the material described are at the user's risk and are the user's responsibility.

© 2022 NOV Inc. All rights reserved.  
JIRA 16604

**Fiber Glass Systems**

17115 San Pedro Ave., Suite 200  
San Antonio, Texas 78232  
USA

**Conroe Office**

500 Conroe Park West Drive  
Conroe, Texas 77303  
USA